

# ATM CASH TRACK

## 1. Purpose

The purpose of the Text Insertion function is to make the DVR accept the text information coming from external devices like ATM machines, cash registers, and access control systems. The DVR stores the text information in the hard disk, and shows the information on the screen during a video playback. Through various interfaces for text review, the user can search for and playback a desired video.

The main functions include:

1. DISPLAY – Desired text information will be shown on the screen in the playback mode.
2. Various TEXT REVIEW interfaces, including:
  - FULL LIST – Lists all the recorded text information page by page for selection.
  - BY STRING – Searches all the text information including the desired strings.
  - BY DATE/TIME - Lists some of the records with the text information within a desired period.
  - BY AMOUNT - Lists some of the records with the text information whose cash amount meets the desired range.
  - BY COMBINATION – Combines the above search interfaces on one and the same page.
3. Various EXCEPTION ALERT monitoring functions, including:
  - ALERT: A Trigger Alert signal after a specific number of exceptions. The number of exceptions and the reset time for the alert can be configurable.
  - BUZZER: The DVR Buzzer sound for exceptions.
  - FLAG: The DVR OSD flag display for exceptions.
  - NOTIFY: Notifies the remote viewer software after an ALERT has been generated.
  - FTP: Transfers images to an FTP server after an ALERT.

## 2. Specifications.

### 2.1 Hardware connection.

Connect the DVR and the text device through the RS-232 Null Modem Cable ( Pin 2, Pin3 Cross over , Pin5 Ground ).

### 2.2 RS-232 baud rate setting.

Baud rates can be set in the DVR, the baud rate selections including 2400, 4800, 9600, 19200, 28800, 38400, 57600 and 115200.

### 2.3 The maximum number of text information records.

For every 10.24 Giga bytes of hard disk capacity, the DVR reserves space for 32768 text records. Each hard disk keeps its own data in itself. In a DVR with two hard disks, the user can remove any one of them, and the remaining one will keep working.

For example, in the case of an 80G hard disk, the maximum number of recorded text information is  $(80 / 11) \times 32768 = 229376$ .

#### 2.4 Data size.

Each text information contains up to 100 characters.

#### 2.5 PROTOCOL.

The DVR supports the following two protocols; please set the appropriate one in the Setup Menu.

##### 2.5.1 **GENERIC.**

All the text data is delimited by CR (Carriage Return = 0x0d ) and LF( Line Feed = 0x0a ).

##### 2.5.2 **VSI-ADD.**

The text data includes CHANNEL information for application in the multi-channel environment as follows:

0x1b, <CH>, <TEXT> , 0x0d.

### 3. Operation

#### 3.1 Settings.

##### 3.1.1 Text Insertion Protocol.

SETUP / RECORD / TEXT INSERTION.

Set one of the following:

###### 3.1.1.1 **GENERIC:**

Text format : <TEXT >+ CR( 0x0d ) + LF ( 0x0a )

###### 3.1.1.2 **GENERIC 2 CH:**

Text format : <TEXT >+ CR( 0x0d ) + LF ( 0x0a )

RS-232(Text channel 1) , RS-485(Text channel 2)

###### 3.1.1.3 **VSI-ADD:**

Text format: 0x1b + Ch + <TEXT> + CR( 0x0d )

**Note:** The Text Insertion activates both the text data and the channel information in a DVR, and the remote viewer software takes effect after this option has been turned on.

##### 3.1.2 RS232 Baud Rate.

SETUP / COMMUNICATION / BAUD

Set at the same speed as that in the Text Input device.

##### 3.1.3 Firmware version and capacity usage.

SETUP / SYSTEM / VERSION.

```

MAC : 00:0C:0C:00:00:10
BIOS : 1.00
SW  : 1.11GBT
DATE: Feb 24 2006

TEXT# : 0/ 229376

PRESS ENTER TO RETURN

```

The 2 numbers after “TEXT # :” are the current index number of the TEXT data and the total number of TEXT data.

### 3.1.4 Text color setting.

There are 8 options (BLUE, ORANGE, RED, MAGENTA, GRAY, WHITE, YELLOW, and GREEN); if the **TEXT INSERTION** option has been set as **VSI-ADD** protocol, and incoming texts come from different channels, all the messages of the channels could be set in different colors are shown as below.

```

          TEXT INSERTION
TEXT INSERTION : OFF
TEXT COLOR     : SET
TEXT DISPLAY   : BY CHANNEL
TEXT STAMP     : ???
REVIEW CONSTRAINT : ???
PHRASE         : #1..10
EXCEPTION      : #1..10

[←] MAIN PAGE
TEXT COLOR

```

```

          TEXT COLOR
CH1  █ WHITE
CH2  █ YELLOW
CH3  █ GREEN
CH4  █ BLUE

```

### 3.1.5 Text display setting.

There are 2 options (BY CHANNEL, MIXED); If the **TEXT INSERTION** option

has been set as **VSI-ADD** protocol, and incoming texts come from different channels, all the messages of the channels could be set in different channels.

**By channel:** This mode shows a 4-channel screen where each channel displays information text against a background of images -- both the text and the images belong to that channel only.

**Mixed:** This mode shows a 4-channel screen where each channel shows its own images only; but the entire screen shows information text overlapping across all the channels. The data for all the channels will show as it comes in, without following any channel sequence by numerical order.

**TEXT INSERTION**

TEXT INSERTION : OFF  
 TEXT COLOR : SET  
 TEXT DISPLAY : BY CHANNEL  
 TEXT STAMP : ???  
 REVIEW CONSTRAINT : ???  
 PHRASE : #1..10  
 EXCEPTION : #1..10

MAIN PAGE

TEXT DISPLAY

**TEXT INSERTION**

TEXT INSERTION  
 TEXT COLOR  
 TEXT DISPLAY \_\_\_\_\_ BY CHANNEL  
 TEXT STAMP MIXED  
 REVIEW CONSTRAINT  
 PHRASE  
 EXCEPTION

MAIN PAGE

TEXT DISPLAY

3.1.6 Phrase setting.

The 100 built-in phrases enable the user to input the strings more quickly. Since users need to change the characters one by one when they input the string value in the search menu or search menu, the phrase offers another shortcut to input the common strings.

Enter SETUP/ RECORD/ TEXT INSERTION/ PHRASE

There are 11 options ( 1..10,11..20,.... 99..100," FACTORY DEFAULT" ); please select one, and then enter the inner page for the string settings. The last one, "FACTORY DEFAULT", is used to go back to the default values.

**TEXT INSERTION**

TEXT INSERTION  
 TEXT COLOR  
 TEXT DISPLAY  
 TEXT STAMP  
 REVIEW CONSTRAINT # 1..10  
 PHRASE \_\_\_\_\_ #11..20  
 EXCEPTION #21..30  
 #31..40  
 #41..50  
 #51..60  
 #61..70  
 #71..80  
 #81..90  
 #91..100

MAIN PAGE

# 1..10

**TEXT INSERTION**

TEXT INSERTION  
 TEXT COLOR  
 TEXT DISPLAY  
 TEXT STAMP  
 REVIEW CONSTRAINT #11..20  
 PHRASE \_\_\_\_\_ #21..30  
 EXCEPTION #31..40  
 #41..50  
 #51..60  
 #61..70  
 #71..80  
 #81..90  
 #91..100  
 FACTORY DEFAULT

MAIN PAGE

FACTORY DEFAULT

PHRASE # 1..10

1	[ACCOUNT	]
2	[ALCOHOL	]
3	[ALE	]
4	[AMERICAN EXPRESS	]
5	[ATM	]
6	[AX	]
7	[BALANCE	]
8	[BASS	]
9	[BEER	]
10	[BOURBON	]

While the users input string data in the setup menu or search menu, they can also press the **SETUP** button to quickly acquire the required or relevant phrases; please see the following examples.

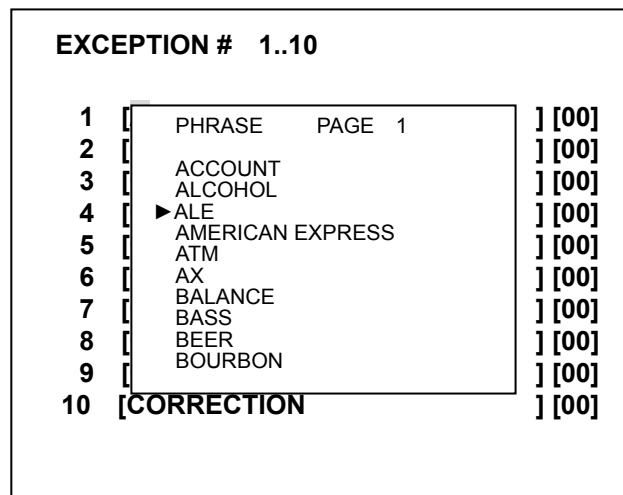
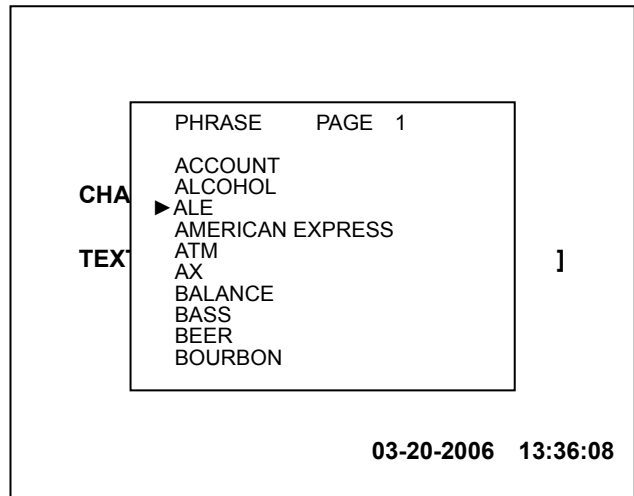
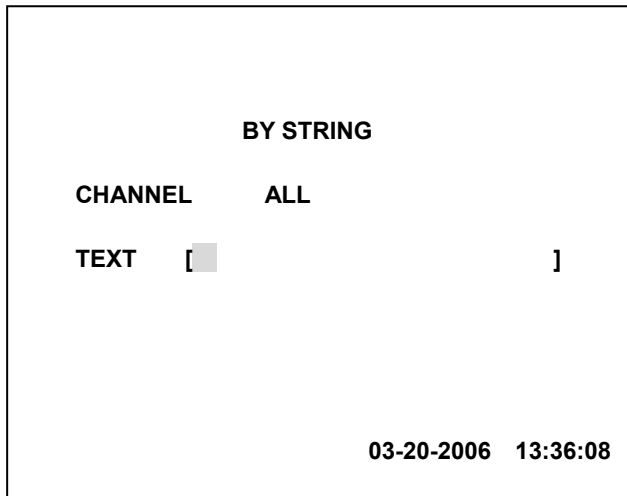

### 3.1.7 Exception setting.

Enter SETUP/ RECORD/ TEXT INSERTION/ EXCEPTION

The purpose of using the exceptions is to filter some special string and alter the remote users. There are 4 options (1 ..10, 11..20, 21..25, "FACTORY DEFAULT" ); please select one, and then enter the inner page for the string settings. The last one, "FACTORY DEFAULT", is used to go back to the default values.

In the right-hand side of the Exception Setting page is the exception count. If a number has been specified, the DVR will alert the remote Viewer Software when the number of the exceptions exceeds the number set here.

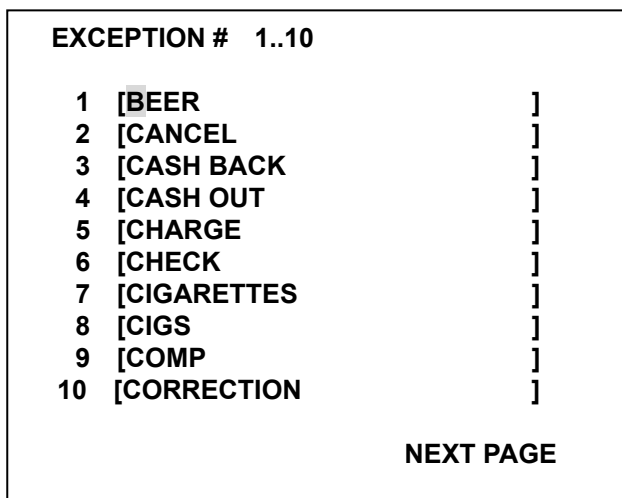
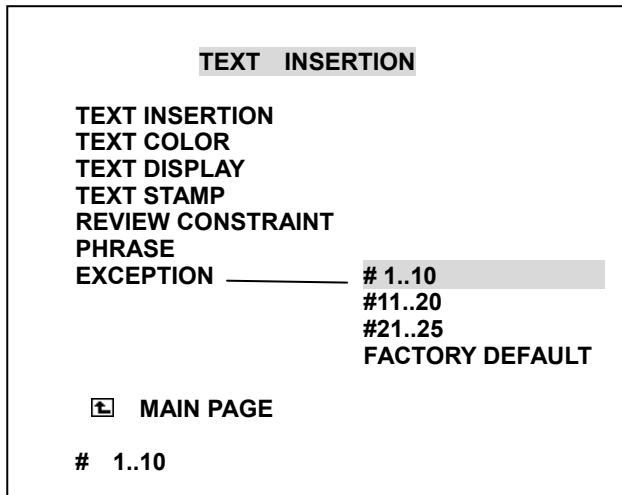

### 3.1.8 EXCEPTION PARAMETER.

In the EXCEPTION setting page, press the SEARCH button to enter the EXCEPTION PARAMETER setting page. In the PARAMETER EXCEPTION setting page, press the SEARCH button to return to the EXCEPTION setting page.

For each EXCEPTION, the user can set the following parameters.

#### 3.1.8.1 CNT ( Count ) 0..99

When the number of exceptions exceeds this number, the DVR will generate an ALERT event. If this number is set as 0, any exception will be ignored.

#### 3.1.8.2 RST ( Reset Time ) 0..24

If no exception has been detected for a certain number of hours, the Exception count ( in 3.1.8.1) will be reset to 0.

**Note: For exception #26, CNT is not used.**

3.1.8.3 BUZ ( Buzzer ) Off/ On.

If the BUZ has been set as ON, the DVR will generate a buzzer sound as a warning when an exception has been detected. The duration depends on the DWELL setting ( 3.1.8.7 ).

**Note: The buzzer setting in SYSTEM/ BUZZER must also be set as ON, or the function will not take effect.**

3.1.8.4 FLG ( Flag ).

If the FLG has been set as ON, the DVR will show a mark ( \* ) on the screen, and keep flashing for a duration depending on the setting in DWELL( 3.1.8.7 ).

3.1.8.5 NFY ( Notify Remote ).

If the NFY setting has been set as ON, the DVR will notify the remote viewer software when the ALERT event has been generated. At the same time, a message “ALT” will be shown on the screen.

3.1.8.6 FTP.

If the FTP setting has been set as ON, the DVR will start to send pictures to an FTP server after the ALERT event has been generated. The rate is fixed at 1f/ 1s, and the duration is 10 sec.

**Note:** The settings in the **FTP SETTING** must also be properly set, or the function will not take effect. The **FTP SETTING/ FTP MODE** item must be set especially as **EXCEPTION**.

3.1.8.7 DWE ( DWELL ).

The durations for the above BUZ ( 3.1.8.3 ) and FLG( 3.1.8.4 ) functions are shown as below.

EXCEPTION # 1..10							
	CNT	RST	BUZ	FLG	NFY	FTP	DWE
1	05	01	ON	ON	ON	OFF	03
2	05	01	ON	ON	ON	OFF	03
3	05	01	ON	ON	ON	OFF	03
4	05	01	ON	ON	ON	OFF	03
5	05	01	ON	ON	ON	OFF	03
6	05	01	ON	ON	ON	OFF	03
7	05	01	ON	ON	ON	OFF	03
8	05	01	ON	ON	ON	OFF	03
9	05	01	ON	ON	ON	OFF	03
10	05	01	ON	ON	ON	OFF	03

PREV PAGE

3.1.9 AMOUNT EXCEPTION.

In the EXCEPTION setting page, #25 is a special item for amount exception. When the amount exceeds this number, the DVR will generate an Exception event, too.

```

EXCEPTION # 21..25

21 [RETURN           ]
22 [TOTAL            ]
23 [VOID             ]
24 [WINE             ]
25 AMOUNT >= 000000.00 (OR <= -N)

NEXT PAGE

```

3.2 System Connection.

3.2.1 Single Device Connection.

When only one Text device ( such as an ATM ) is used, please set the setting in the Setup Menu according to 3.1.1.1.

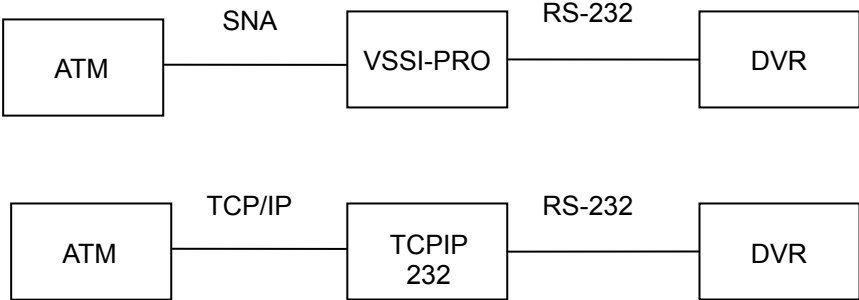

3.2.2 Multiple Devices Connection.

By using VSSI-PRO , REGCOM and HYDRA, a multiple ATM can be linked together through an RS-485, and can finally connect to the DVR through the RS-232.

The following is an example of 4 ATM connected to a DVR.

For proper setting, please refer to 3.1.1.3 section in this chapter.

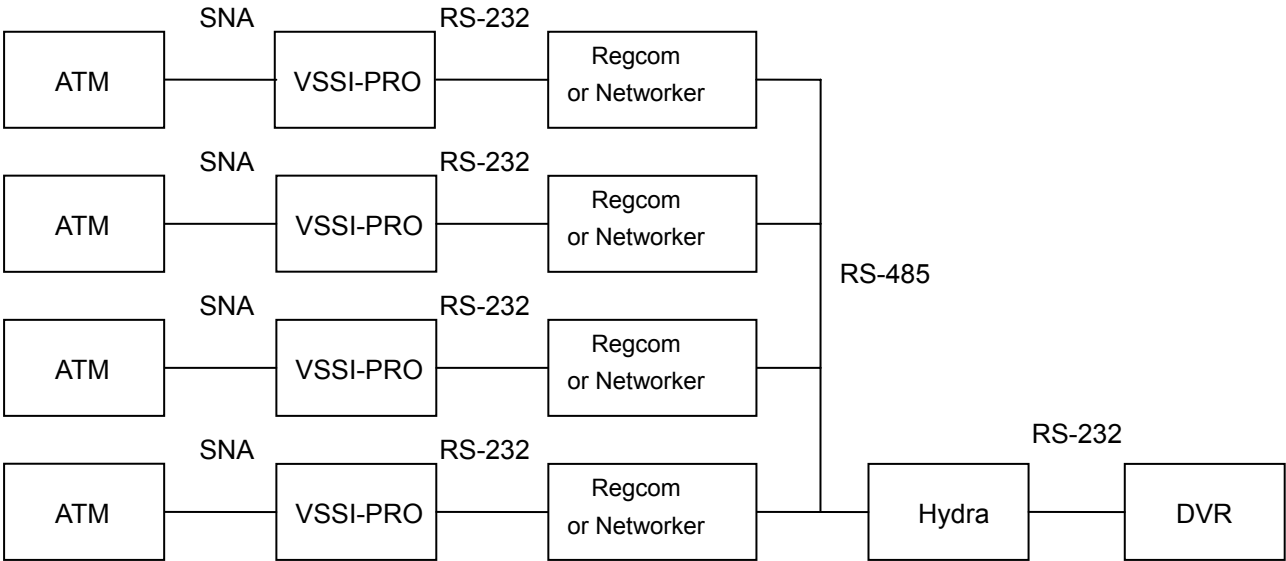



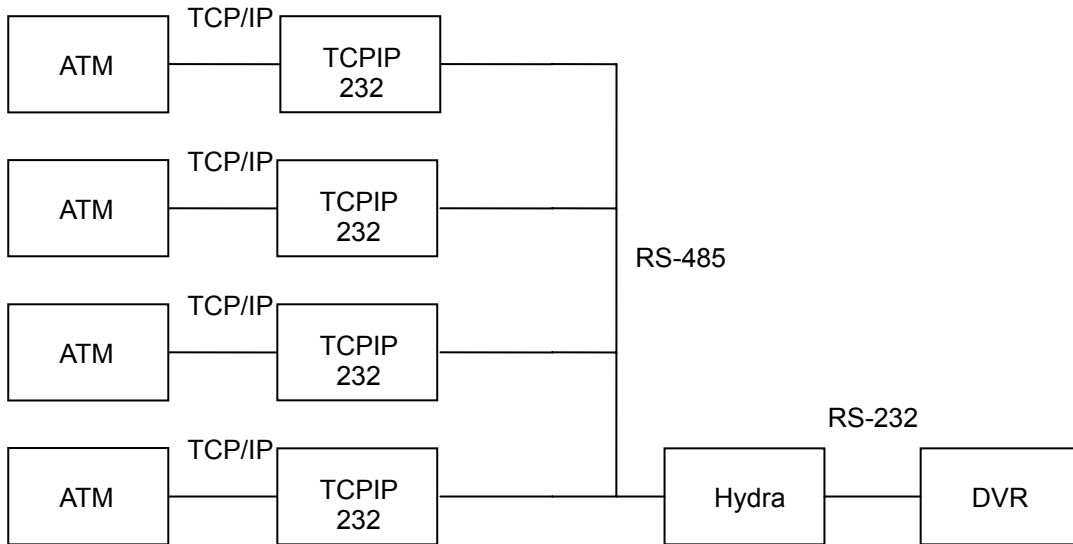

### 3.2.3 LIVE DISPLAY.

After the hardware has been connected, please power up the DVR. The DVR is by default in the LIVE mode. Press the **DISPLAY** button to switch to different display modes; under any one of the following modes, the contents of the received text data will be shown on the screen.

#### 3.2.3.1 Simple Text Display Mode.

An example:

On the left-lower corner, the OSD message "TRANSACTION BEGIN" is the newest incoming TEXT data.

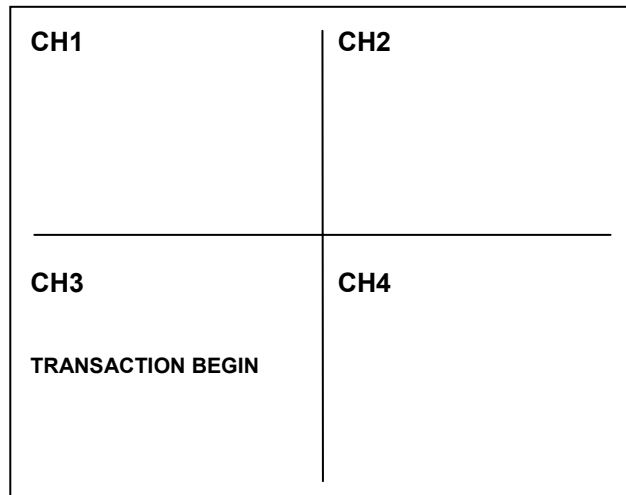

#### 3.2.3.1 Full Text Display Mode.

All the incoming TEXT data are shown in the middle of the screen; the previous data is scrolled up when the latest one arrives.

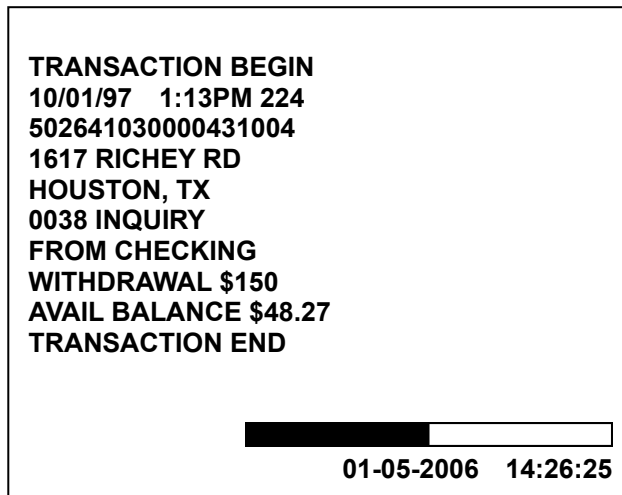

If the TEXT INSERTION option has been set as **VSI-ADD**, and incoming texts come from different channels.

A percentage bar in the right-lower corner reveals the text data usage. For example, if the total number of text data is 65536 and the number of the current used text data is 32768, the bar will be shown about 50% full. For the precise number please refer to SETUP/ SYSTEM/VERSION in the local device OSD.

#### 3.2.4 RECORDING

When the text data continuously inputs from the Text device, press the REC button to activate recording; while the DVR is in the RECORD mode, there is a small red ball periodically flashing in the right-upper corner of the screen. Please press the DISPLAY button to switch to a desired mode to observe the incoming TEXT data. To stop recording, please press the REC button and hold for more than 3 seconds before releasing.

#### 3.2.5 PLAYBACK.

Press the SEARCH button to enter the Search Menu, highlight a desired item in the list, and then press the ENTER button to start playback. During playback, the DISPLAY can also be used to switch to the display modes, to see the Text data that was received when the corresponding video was recorded. The Text data is shown even in the trick play mode, like fast forward and slow motion.

If the TEXT INSERTION option has been set as **VSI-ADD** and incoming texts come from different channels.

#### 3.2.6 REVIEW TEXT.

Press the **SEARCH** button and hold for more than 3 seconds. The **REVIEW TEXT** mode will then be activated, with 6 items for selection.

**REVIEW TEXT**

**FULL LIST**  
**BY STRING**  
**BY DATE / TIME**  
**BY AMOUNT**  
**BY COMBINATION**  
**ALERT LOG**

3.2.6.1 FULL LIST.

If the TEXT INSERTION in the Setup Menu is set as **GENERIC** (refer to 3.1.1 section in this chapter), the list is shown as below.

```

HD1
1013 01-05-06 14:13:22 TRANSACTION
1014 01-05-06 14:13:22 10/01/97 1:13PM 224
1015 01-05-06 14:13:22 502641030000431004
1016 01-05-06 14:13:22 1617 RICHEY RD
1017 01-05-06 14:13:22 HOUSTON, TX
1018 01-05-06 14:13:22 0038 INQUIRY
1019 01-05-06 14:13:22 FROM CHECKING
1020 01-05-06 14:13:22 AVAIL BALANCE $48.2

AVAIL BALANCE $48.27

                                01-05-2006 14:26:25

```

Alternately, if the TEXT INSERTION is set as **VSI-ADD**, the following channel selection screen will be shown first as the input of the desired channel. The selectable options are ALL, CH1, CH2, CH3 and CH4.

```

                                FULL LIST

CHANNEL  ALL

                                01-05-2006 14:26:25

```

Once a channel is selected and the **ENTER** button is pressed, all the Text Data of the particular channel will be listed.

HD1				CH	1	2	3	4
781	01-02-06	11:34:12	TRANSACTION					
782	01-02-06	11:34:12	10/01/97	1:13PM	224			
783	01-02-06	11:34:12	HOUSTON, TX					
784	01-02-06	11:34:13	0038 INQUIRY					
785	01-02-06	11:34:13	FROM CHECKING					
786	01-02-06	11:34:13	AVAIL BALANCE \$48.2					
787	01-02-06	11:34:13	502641030000431004					
788	01-02-06	11:34:13	TRANSACTION END					
TRANSACTION END								
01-02-2006 18:59:25								

### 3.2.6.2 BY STRING.

The "BY STRING" function offers an interface to search for some specific material. The text may include names of personnel, goods, cash totals and balances, and/ or other miscellaneous items. If you want to access the records of a particular goods, see the "TEXT" entry and type in its name. At once you may find classifications, appearing under the category of that particular goods if such classifications exist. If you enter "TRANSACTION", you'll see both "TRANSACTION" and "TRANSACTION END" listed, for instance. You can highlight the one you want, and start to playback. If the TEXT INSERTION is set as **GENERIC**, the "BY STRING" screen will have only a "TEXT" string as input. Up to 16 characters can be input for searching.

If the TEXT INSERTION is set as **VSI-ADD**, there is a channel item which will show on the screen, too.

<b>BY STRING</b>	
<b>CHANNEL</b>	<b>ALL</b>
<b>TEXT</b> [	]
01-02-2006 19:26:55	

To search for a two-word string, please enter the words with one space between the words, for example, "TRANSACTION"

```

          BY STRING
CHANNEL    ALL
TEXT [TRANSACTION ]

                                01-02-2006 19:27:30

```

### 3.2.6.3 BY DATE/ TIME.

This function offers an interface to list the data within a specific time period. If the TEXT INSERTION is set as **GENERIC**, the "BY DATE/ TIME" screen will have starting DATE TIME items and ending DATE/TIME items as inputs. If the TEXT INSERTION is set as **VSI-ADD**, there is a channel item which will be shown on the screen, too

```

          BY DATE / TIME
CHANNEL    CH1
MM  DD  YEAR  HH  MM  -
01 / 02 / 2006 00  00

MM  DD  YEAR  HH  MM
01 / 02 / 2006 23  59

                                01-02-2006 19:29:02

```

### 3.2.6.4 BY AMOUNT.

This function offers an interface to search above and under a particular amount across the transactions recorded in the different channels.

If the TEXT INSERTION is set as **GENERIC**, the "BY AMOUNT" screen will have only 2 sets of entries each under "OPERATION" and " AMOUNT" as inputs.

The selectable operations are ">=", ">", "=", "<" and "<=".

If the TEXT INSERTION is set as **VSI-ADD**, there is a channel item which will show on the screen, too.

BY AMOUNT	
CHANNEL	CH1
OPERATION	AMOUNT
>=	0000.00
--	0000.00
01-02-2006 19:31:33	

The following are some examples for your operations.

A. To search Amount  $\geq$  1.00, the following items are shown on the screen.

>= 00001.00  
 -- 00000.00

B. To search Amount  $\leq$  1.00, , the following items will be shown on the screen.

$\leq$  00001.00  
 -- 00000.00

C. To search Amount = 1.00 , the following items appear on the screen.

= 00001.00  
 -- 00000.00

D. To search  $1.00 \leq$  Amount  $\leq$  10.00, the following items will show on the screen.

>= 00001.00  
 $\leq$  00010.00  
 or  
 $\leq$  00010.00  
 >= 00001.00

E. To search Amount  $\leq$  1.00 OR Amount  $\geq$  10.00, the following items will be shown on the screen.

>= 00010.00  
 $\leq$  00001.00  
 or  
 $\leq$  00001.00  
 >= 00010.00

**Note:** If two operations are set and those two are exclusive of each other, the system will automatically add an "OR" between them. Otherwise, the system adds an "AND" between them.

### 3.2.6.5 BY COMBINATION

BY COMBINATION	
CHANNEL	ALL
STRING	SET
BEER	
DATE/ TIME	SET
00/00/0000 00:00:00 -	
00/00/0000 23:59:00	
AMOUNT	SET
>= 0010.00	
◀▶ MOVE ▲▼ CHANGE ◻ SEARCH	

BY COMBINATION is the combination of the above search interfaces. The user can give the different conditions on the same page. The search procedure can be repeated between the BY COMBINATION page and the search result page ( TEXT LIST ).

If the TEXT INSERTION is set as **VSI-ADD**, there is a channel item which will show on the screen, too.

In this page, please use the < and > buttons to move between items, and use the ^ and v buttons to change the values. Once the value has been set to "SET", please press the **ENTER** button to enter the "BY STRING", "BY DATE/ TIME" and " BY AMOUNT" pages for further settings. For the operations in the lower level pages, please refer to section 3.2.6.2, 3.2.6.3 and 3.2.6.4 in this chapter. When you are in those lower level pages, press the **ENTER** button to go back to " BY COMBINATION". After all the conditions have been set properly, please press the **SEARCH** button to start searching. In the "TEXT LIST" page, please press the **ENTER** button to start playback, and press the **SEARCH** button to return to the "BY COMBINATION" page.

### 3.2.6.6 REVIEW CONSTRAINT

If the item has been set as any of the monthly options( between 1-4 months ), all search functions on the REVIEW TEXT page will fall within that constraint. This function is for improving the speed for the REVIEW TEXT function.

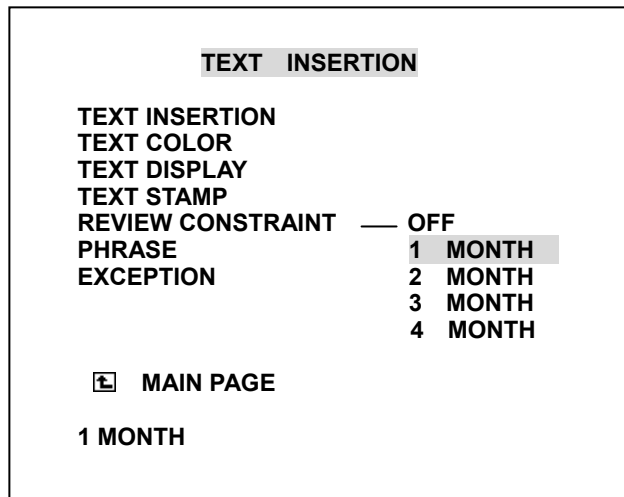

### 3.2.7 ALERT LOG

The Alert Log keep the latest 100 alerts for check and playback, the records marked as “>” are playable. Some alert could not be played back since it occurred when DVR was not in the RECORD mode. Please press ENTER button on the playable item to start the playback.

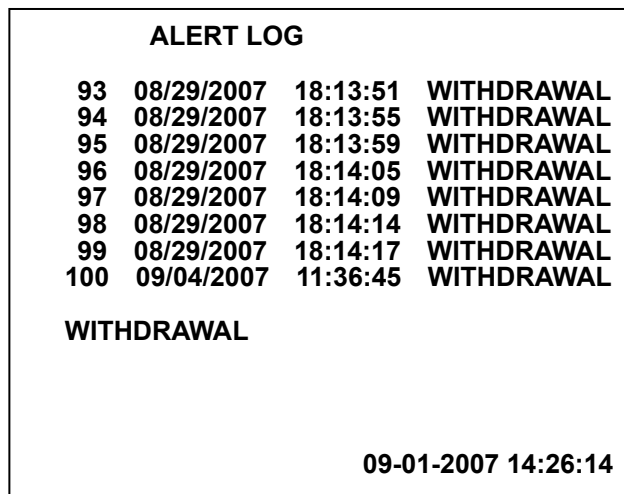

### 3.2.8 LOAD/ SAVE the Text Insertion Setting

For quickly save and load the settings onto the SD card, please enter the setup menu, SETUP/ SYSTEM/ SD SETUP/ ( LOAD/ SAVE )

The filename is TEXTINS.BIN

### 3.2.9 Text data stamp on AVI file

The successive text data will be stamped as continuously input feedback over the AVI pictures. The text data will either be stamped on different corners for different channels, or there will be a mixed display ( combining all the channels together), depending on the TEXT DISPLAY setting in the Setup menu/ RECORD/ TEXT INSERTION page.



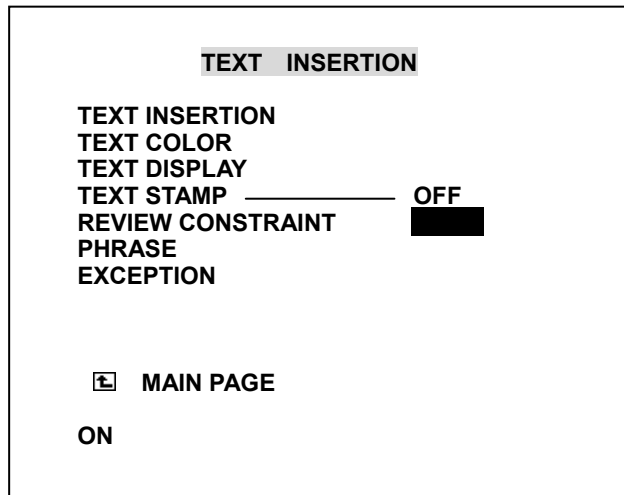

The AVI file playbacked in Microsoft Media Player



### 3.2.10 ATM data backup

The DVR will extract the ATM data from the video data and save it to an SD card as a text-only file.

Enter the Setup menu/ DISK / HD BACKUP/ TXT TO SD CARD

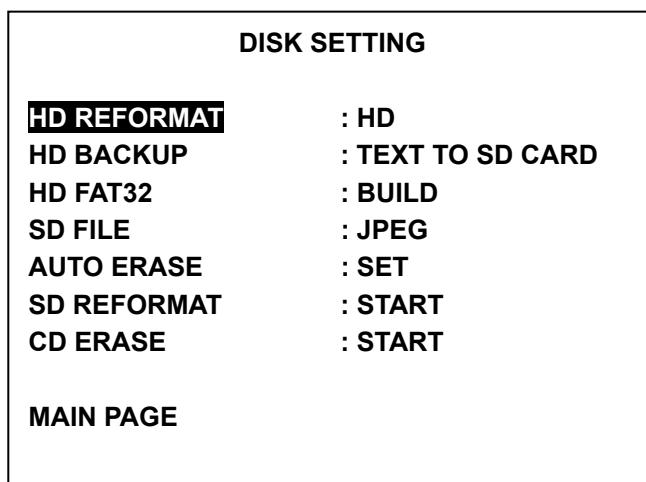

The exported pure text file.

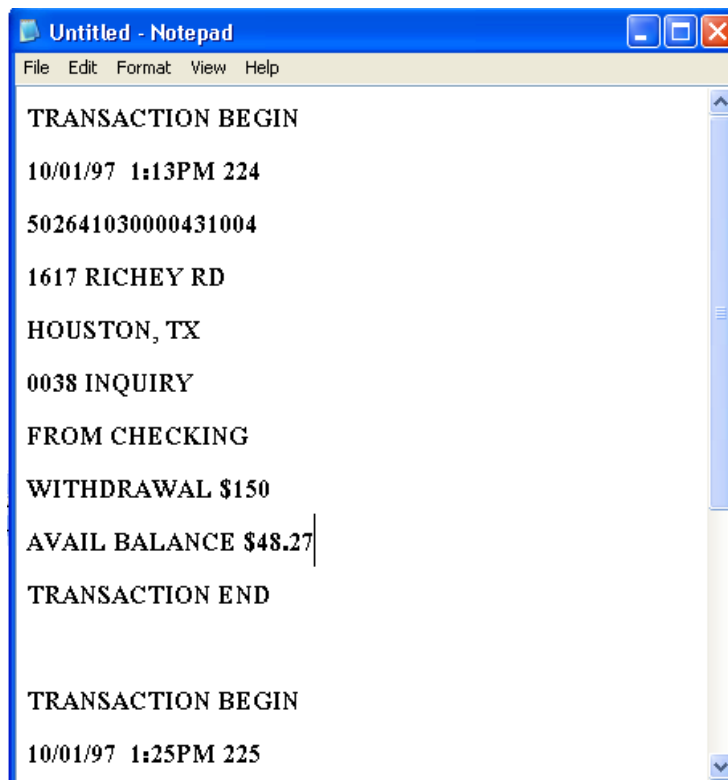

The image shows a screenshot of a Notepad window titled "Untitled - Notepad". The window has a menu bar with "File", "Edit", "Format", "View", and "Help". The text content is as follows:

```
TRANSACTION BEGIN  
10/01/97 1:13PM 224  
502641030000431004  
1617 RICHEY RD  
HOUSTON, TX  
0038 INQUIRY  
FROM CHECKING  
WITHDRAWAL $150  
AVAIL BALANCE $48.27  
TRANSACTION END  
  
TRANSACTION BEGIN  
10/01/97 1:25PM 225
```